

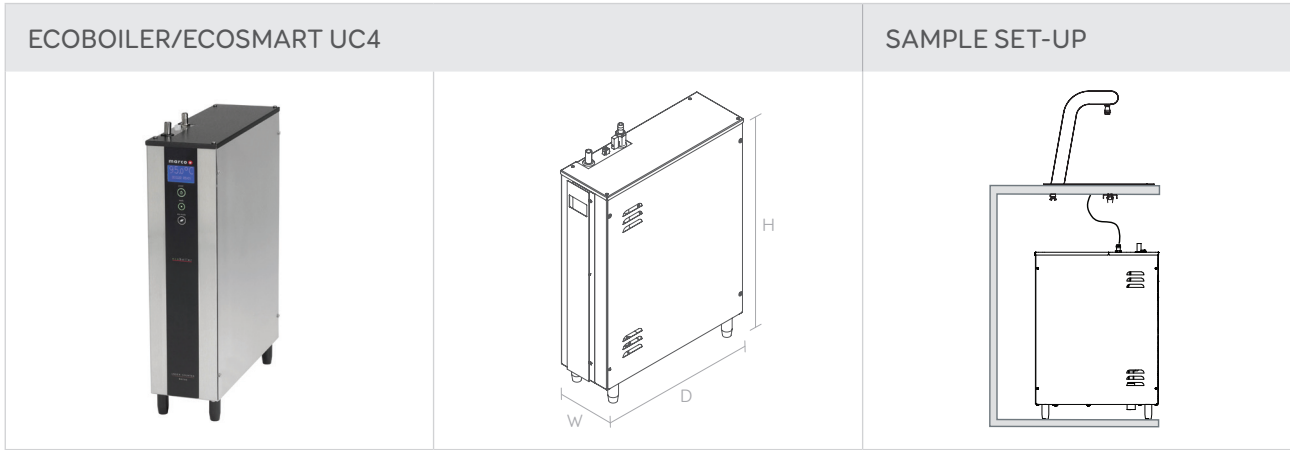

ECOSMART UC4



FONTS

	PRODUCT INFO	FONT DIMENSIONS			PACKAGING		
		NAME ORDER CODE	DIMENSIONS INCL. DRIP TRAY (D x W x H mm)	DIMENSIONS EXCL. DRIP TRAY (D x W x H mm)	TAP TO COUNTER (T mm)	PACKED WEIGHT	PACKAGING DIMENSIONS (L x W x H mm)
	1b Una Font 1000859	168 x 120 x 287	138 x 30 x 287	233	2kg	290 x 570 x 215	30
OR	Über Font 1 connection 1000812	470 x 250 x 400	n/a	295	7kg	490 x 280 x 670	24
	Über Font 2 connections 1000811						
OR	Über Font (Low) 1 connection 1000812L	470 x 250 x 272	n/a	172	7kg	490 x 280 x 670	24
	Über Font (Low) 2 connections 1000811L						

BOILERS

NAME ORDER CODE	WATER TYPE	SIZE	PERFORMANCE SPECS			PLUMBING & ELECTRICAL REQ		PACKAGING		
	TEMP ADJUST	DIMENSIONS (D x W x H mm)	IMMEDIATE DRAW OFF	L/HR	CUPS /HR	POWER @220V	PLUMBING REQS	PACKAGING DIMENSIONS (L x W x H mm)	PACKED WEIGHT	QTY/ PALLET
Ecosmart UC4 1000750	Y	395 x 135 x 585	4L	28L	156	2.8kW	3/4" BSP	510 x 240 x 690	11kg	20
Ecoboiler UC4 1000740	N			24L	133	2.4kW				

ECOSMART UC4

1 BUTTON UNA FONT WITH ECOBOILER UC4 / ECOSMART UC4

COUNTER CUT-OUT WITH DRIP TRAY

1b UNA FONT 1000859

ECOBOILER UC4
1000740

ECOSMART UC4
1000750

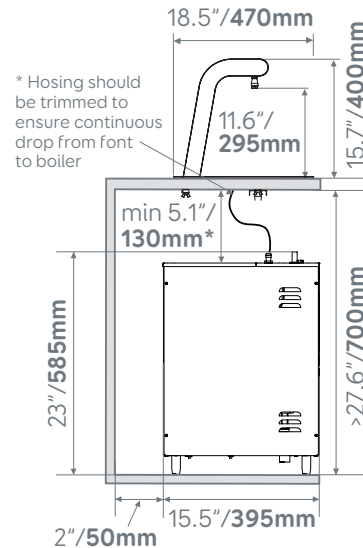
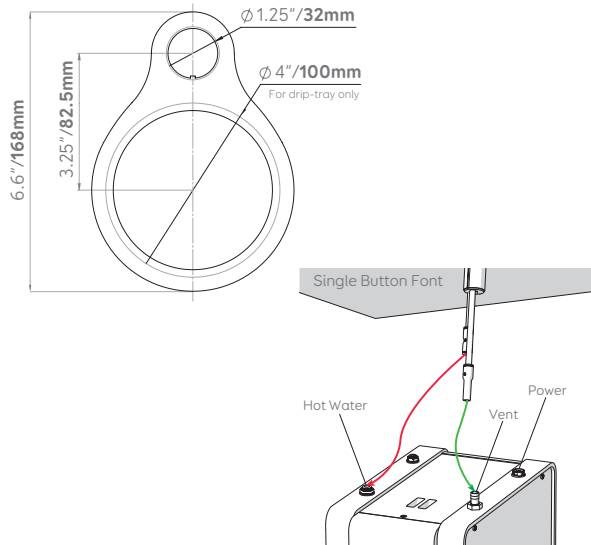

VENTILATION REQUIREMENTS

50mm/1.9" clearance required at each side and back of machine if installed in an enclosed cabinet.

ELECTRICAL INSTALLATION PROCEDURE

When installing the machine, always observe the local regulations and standards. The standard machine is supplied with a UK 3-pin plug. For EU models a 2-pin CEE-7 plug will be supplied. US models will be supplied with the suitable plug. A suitable mains power supply socket should be available within easy access of the appliance so that it can be disconnected easily after install.

PLUMBING INSTALLATION PROCEDURE

- Ensure that the equipment is installed according to local plumbing & water regulations.
- Mains water pressure required (limits): 14.5 - 145psi (100 - 1000kPa, 0.1 - 1MPa).
- Requires inline water filter within your water specifications.
- The machine is supplied with a 3/4" BSP connection.
- Turn on the water to flush any impurities, dust etc from the inlet hose and water pipe. Allow several litres through. Especially for new installations.
- Connect the hose to the inlet valve of the boiler. Make sure a sealing washer is fitted.
- Turn on water and check for leaks.

OPERATING BOILER FOR THE FIRST TIME

- Check that all installation procedures have been carried out.
- Ensure water valve is on.
- Plug boiler appropriate electrical supply and press power button on the front of the machine marked 'Power'.
- The "power on" light will glow green and the machine will fill to a safe level, above the elements, before heating.
- The "Ready/Status" light will cycle two red flashes while the machine is filling to the safe level.
- Whilst the machine is above the safe level and filling, the "Ready/Status" light will remain blank.
- The "Ready/Status" light will glow green when the machine is both full and up to normal operating temperature.
- The boiler is now ready for use.
- The font is simply activated by pressing the button on the top of the font.

NOTE: Because the boiler is electronically controlled no priming is necessary. The element cannot switch on until a safe level of water is reached.

ECOSMART UC4

ÜBER FONT WITH ECOBOILER UC4 / ECOSMART UC4

COUNTER CUT-OUT

ÜBER FONT 1000811

ECOBOILER UC4
1000740

ECOSMART UC4
1000750

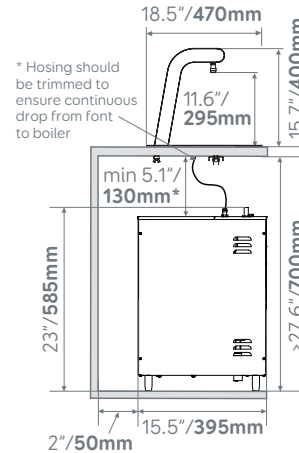
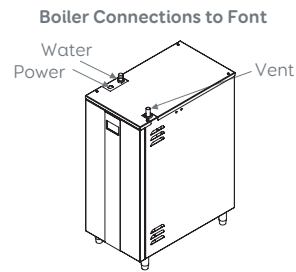
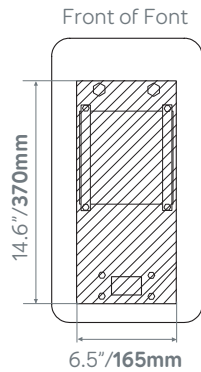

VENTILATION REQUIREMENTS

50mm/1.9" clearance required at each side and back of machine if installed in an enclosed cabinet.

ELECTRICAL INSTALLATION PROCEDURE

When installing the machine, always observe the local regulations and standards. The standard machine is supplied with a UK 3-pin plug. For EU models a 2-pin CEE-7 plug will be supplied. US models will be supplied with the suitable plug. A suitable mains power supply socket should be available within easy access of the appliance so that it can be disconnected easily after install. The wires from the font are terminated in a Mini Fit connector which will plug into a similar Mini Fit connector mounted on the top lid of the undercounter boiler.

PLUMBING INSTALLATION PROCEDURE

- Ensure that the equipment is installed according to local plumbing & water regulations.
- Mains water pressure required (limits): 14.5 - 145psi (100 - 1000kPa, 0.1 - 1MPa).
- Requires inline water filter within your water specifications.
- The machine is supplied with a 3/4" BSP connection.
- Turn on the water to flush any impurities, dust etc from the inlet hose and water pipe. Allow several litres through. Especially for new installations. Connect the hose to the inlet valve of the boiler. Make sure a sealing washer is fitted.
- Turn on water and check for leaks.
- If the overflow vent is plumbed it must be plumbed with a tundish device.

- This equipment must be installed with adequate backflow protection to comply with all applicable federal, state and local codes.

OPERATING BOILER FOR THE FIRST TIME

- Check that all installation procedures have been carried out.
- Ensure water valve is on.
- Plug boiler appropriate electrical supply and press power button on the front of the machine marked 'Power'.
- The "power on" light will glow green and the machine will fill to a safe level, above the elements, before heating.
- The "Ready/Status" light will cycle two red flashes while the machine is filling to the safe level.
- Whilst the machine is above the safe level and filling, the "Ready/Status" light will remain blank.
- The "Ready/Status" light will glow green when the machine is both full and up to normal operating temperature.
- The boiler is now ready for use.
- The font is simply activated by pressing the button on the top of the font.

NOTE: Because the boiler is electronically controlled no priming is necessary. The element cannot switch on until a safe level of water is reached.